



04-07. August 2022.

SUPPLEMENTARY REGULATIONS

Visa numbers:

MAMS Nr:

EMN Nr:

IMN Nr: 814/05

CONTENTS

INTRODUCTION	3
PROGRAM	3
1. DESCRIPTION	5
2. ORGANIZATION	6
3. ENTRIES	7
4. INSURANCE	8
5. ADVERTISING / IDENTIFICATIONS	9
6. TYRES	9
7. FUEL	9
8. ADMINISTRATIVE CHECKS	9
9. TECHNICAL SCRUTINEERING, SEALING AND MARKING	10
10. QUALIFYING STAGE	11
11. START OF THE EVENT	11
12. RUNNING OF THE EVENT	11
13. FIXED PENALTY	12
14. SERVICE PARK	13
15. FINAL CHECKS / PROTEST / APPEALS	14
16. RESULTS	14
17. PRIZES	14
APPENDIX 1. – COMPETITOR RELATIONS OFFICERS	15
APPENDIX 2. – TIMETABLE	16
APPENDIX 3. – INSTRUCTION FOR GPS TRACKING SYSTEM	18
APPENDIX 4. – GPS TRACKING SYSTEM KIT COMPONENTS	30

INTRODUCTION

Name of the event: 19th HunGarian Baja 2022

Date of the event: 04-07.August.2022.

Preamble:

„Hungarian Baja 2022” will be run in compliance with:

- FIM Bajas World Cup Regulations
- FIM Sporting Code and FIM Disciplinary & Arbitration Codes
- FIM Medical Code
- FIM Anti-Doping Code
- FIM Environmental Code
- FIM Code of Ethics
- Present Supplementary Regulation and its appendices /SR/
- Official bulletins
- Traffic regulations of Hungary

The current FIM Regulations & Codes are available on: <https://www.fim-moto.com/en/documents>

Any modifications, amendments and/or additions to the Rules and Regulations shall be made in the form of numbered and dated bulletins. Additional information will be published in the Rally Guide on 01. 06. 2022 on the official website: www.hungarianbaja.com

HunGarian Baja is the 5th Round of the FIM Bajas World Cup 2022.

Modifications, amendments and/or changes to this Supplementary Regulation will be announced by numbered and dated bulletins (issued by the Organizer and approved by the FIM and National Motorsport Federation of Hungary (MAMS) up to the time of the first Jury meeting and thereafter by the FIM International Jury.

The World Cup is running in parallel with the International Open Baja Cup (Bike, Quad), with separate regulations, starting after all FIM competitors, using the same special stages in the same time.

The official time will be as GPS (Hungarian time = CET = GMT + 1).

OFFICIAL LOCATIONS

REGISTRATION	SUZUKI MÉSZÁROS 8100. Várpalota, Grábler Tó str. 10.	N47°11'58 E18°19'13
SERVICE	GÁL GYULA SPORS HALL parking lot 8100. Várpalota, Fehérvári str. 9.	N 47°11'59.4132" E 18°8'48.7926"
SCRUTINEERING	SUZUKI MÉSZÁROS 8100. Várpalota, Grábler Tó str. 10.	N47°11'58 E18°19'13
RACE OFFICE / HQ	THURY CASTLE 8100. Várpalota, Hunyadi Mátyás Tér 1.	N47°12'05 E18°08'20
PARC FERMÉ	FŐTÉR 8100. Várpalota, Szabadság Tér	N47°11'58 E18°08'26

PROGRAMME

	LOCATION:	DATE:	TIME:
Publishing of the supplementary regulations	www.hungarianbaja.com		
Entries open	Garilla Racing Kft. 8200 Veszprém, Házgyári str.1. +36307914270 info@hungarianbaja.com www.hungarianbaja.com	01.06.2022.	10:00
Organiser's office opening			
Media Accreditation Start			
Issuing of Rally Guide			
Closure date of entries with reduced fees		11.07.2022	24:00
Closure date of entries		25.07.2022	20:00
Closing date for order of extra service in SP			

1. DESCRIPTION

1.1 PLACES, AND DATE OF THE EVENT:

PLACE: Várpalota, Hungary

DATE: 04-07. August 2022.

1.2 TITLES FOR WHICH THE HunGarian Baja COUNTS:

FIM Bajás Word Cup and International Open Baja Cup (2022)

MAMS International Open Baja Cup, with International Participants

1.3 VISA NUMBERS:

MAMS Nr:

EMN Nr:

IMN Nr: 814/05

1.4 LOCATION OF BAJA OFFICE:

From 01.06.2022 GARILLA RACING KFT.
H- 8200 Veszprém, Házgyári str.1.
Tel: +36-30-791-4270
e-mail: info@hungarianbaja.com
web: www.hungarianbaja.com

From 03.08.2022 Thury Castle, Hunyadi Mátyás Tér 1., 8100 Várpalota
GPS COORDINATE: N47°12'05 E18°08'20

1.5 LOCATION START AND FINISH:

Leg 1: Departure from Parc Fermé and Start to the road section for the Qualifying Special Stage (QSS.) from Várpalota Főtér, Szabadság Tér, starting at 16:45 h. on Friday 05th Aug, 2022. The estimated arrival of Leg QSS to the Parc Fermé will be at 20:30 Várpalota Főtér, Szabadság Tér.

Leg 1 Section2: Departure from Parc Fermé for Leg1 Section2 will start at 08:10 h. in Várpalota Főtér, Szabadság Tér on Saturday 6th Aug. The arrival of Leg1 Section2 to Parc Fermé will be at 16:45 Várpalota Főtér, Szabadság Tér.

Leg 2: Departure from Parc Fermé for Leg 2 will start at 08:15 h. in Várpalota Főtér, Szabadság Tér on Sunday 7th Aug. Arrival of Leg 2 to Parc Fermé will be at 13:25 Várpalota Főtér, Szabadság Tér.

1.6 PRESS OFFICE OPENING SCHEDULE:

LOCATION:	Thury Castle, Hunyadi Mátyás Tér 1., 8100 Várpalota		
TIME:	Friday	05. August 2022	08:00-21:00 hrs
	Saturday	06. August 2022	07:00-19:00 hrs
	Sunday	07. August 2022	08:00-16:00 hrs

1.7 LOCATIONS OF NOTICE BOARD:

Digital Notice Board (DNB): [Sportity](https://www.sportity.com), www.chromomoto.hu, www.hungarianbaja.com



On PC: https://webapp.sportity.com/channel/HGB22_FIM

1.8 LOCATION PARC FERMÉ:

Várpalota Főter GPS COORDINATE: N47°11'58, E18°08'26
Szabadság Tér, 8100 Várpalota

1.9 LOCATION SERVICE PARK:

GÁL GYULA SPORS HALL parking lot
8100. Várpalota, Fehérvári str. 9. GPS COORDINATE: N 47°11'59.4132" E 18°8'48.7926"

2. ORGANIZATION

2.1 ORGANIZER'S NAME:

Name of the organizers: **Garilla Racing Kft. and Garzone s.r.o.**
Name of the National Sporting Authority: **MAMS** (National Motorsport Federation of Hungary)

2.2 ADDRESS & CONTACT DETAILS:

GARILLA RACING KFT. H- 8200 Veszprém, Házgyári str. 1.
e-mail: info@hungarianbaja.com
web: www.hungarianbaja.com

2.3 ORGANIZING COMMITTEE:

Patron of the Event: Mr. Péter OVÁDI
Parliamentary Representative of Veszprém
Mrs. Márta CAMPANARI-TALABÉR
Mayor of Várpalota
Mr. Csaba KATONA
Vice Mayor of Várpalota

President of the Organizing Committee
Members of the Organizing Committee

Mr. Zoltán GARAMVÖLGYI
Mr. Ferenc SCHEIBENHOFFER
Mr. Sándor NÉMETH

2.4 JURY OF THE MEETING:

President of the Jury (FIM) Mrs. Juvana Poulsen (Licence: 14709)
Member of the Jury (FIM) Mr. Adel Noura (Licence: 14269)
Member of the Jury (MAMS) Mrs. Brigitta VARGA

2.5 OBSERVERS and DELEGATES:

Technical Director (FIM) Mr. Izak Santej (Licence: 15077)

2.6 SENIOR OFFICIALS:

Clerk of the Course	Mr. János FALICS
Deputy of Clerk of the Course	Mr. Richard KELEMEN
Environmental Steward	Mr. Péter BAKÓ
Chief Technical Scrutineer	Mr. Gábor FARKAS
Chief Safety Officer	Mr. Sándor NÉMETH
Deputy of Safety Officer	Mr. Ferenc SCHEIBENHOFFER
	Mr. Ádám TÓTH
	Mr. László BALOGH
	Mr. Zsolt TÓTH
	Mr. Zsolt MICZINGER
Chief Medical Officer	Dr. Zoltán PÁLL
Timekeeping and Results Officer	Mr. Csaba GLÜCK
Crews' Relations Officer	Mr. István MÁTRAI
	Mrs. Marianna MAGYAR KELEMENNÉ
GPS Control	STELLA

Secretary of the Rally
Secretary to the Jury
Press Relations Officers
Responsible for the Road Book
Responsible for checking the Road Book

Ms. Julianna TÖRÖK
Mrs. Éva HORVÁTH
Ms. Anita TÓTH
Mr. Roland PÁLINKÁS
Mr. Péter FALUVÉGI

2.7 IDENTIFICATION OF OFFICIALS:

Competitors Relation Officer "CRO" Pink tabard
Scrutineers "ATB" Blue tabard or shirt
Post Chiefs: "VEZETŐBÍRÓ" Red tabard
Special Stage Commanders: "VEZETŐBÍRÓ" Red tabard
Marshals: "SAFETY" / "SPORTBÍRÓ" Yellow or White tabard
Timekeepers: "CHRONOMOTO" Black shirt

3. ENTRIES

3.1 OPENING AND CLOSING DATES:

OPENING date for ENTRIES:	Tuesday, 01. 06. 2022.	10:00 hrs
CLOSING date for <u>REDUCED ENTRY FEE</u> :	Monday, 11. 07. 2022.	24:00 hrs
CLOSING date for ENTRIES:	Monday, 25. 07. 2022.	20:00 hrs

3.2 ENTRY PROCEDURE:

Entries must be made using the online forms on the website www.hungarianbaja.com.

Anybody wishing to take part in the Event must send the Entry Form, duly completed, along with the proof of payment of the entry fee to the Organizer by e-mail: info@hungarianbaja.com

Each competitor should have a valid FIM Competition Licence Entrant/Competitors 2022.

3.3 NUMBER OF ENTRIES AND CLASSES:

The maximum number of entrants will be 100.

If more than 100 entries are received, the Organiser has the right to decide which entries among the non-priority drivers will be accepted. Drivers with points for the FIM Bajans World Cup 2022 will be accepted.

CATEGORY 1 – BIKES

CATEGORY 2 – QUAD

CATEGORY 3 – SSV

CLASS 1 – Women

CLASS 2 – Junior

CLASS 3 – Veterans

3.4 ENTRY FEES

3.4.1. With organiser's optional advertising:

EUR 950	payment transferred up to closing date with reduced entry fee: 11.07.2022
EUR 1250	up to entry closing date: 25.07.2022

Without organiser's optional advertising:

EUR 1520	payment transferred up to closing date with reduced entry fee: 11.07.2022
EUR 2000	up to entry closing date: 25.07.2022

The entry fee includes:

- Additional compulsory liability insurance
- Basic service plate/competing vehicle (1)
- Basic service area per vehicle (50m2)

3.4.2. TO BE PAYED ON SITE:

- | | |
|--|-------|
| - Deposit for the STELLA GPS navigation and safety tracking system: | 100 € |
| - STELLA GPS navigation and safety tracking system's Rental fee | 200 € |
| - STELLA GPS navigation and safety tracking system's Installation Kit | 60 € |

3.4.3. OTHER FEES:

- | | |
|---|-------|
| - Additional permission to the service park (Assistance sticker / service plate): | 100 € |
| - Additional service area (50m 2): | 100 € |

3.5 PAYMENT

Any entry not accompanied by the entry fee shall be null and void. The entry fee shall be paid by bank transfer to the account indicated below (the adequate proof of payment must be attached to the entry form):

Slovenská Sporiteľna, a.s. Bank	Garzone s.r.o Account holder
SK2609000000005063476359 IBAN	GIBASKBX BIC

Payment details: HUNGARIAN BAJA 2022, and full name of the DRIVER

Any entry which is not accompanied with the entry fee will be considered as a preliminary one.

3.6 REIMBURSEMENT

The entry fee shall be refunded in full:

- if the event does not take place
- to teams whose entry application is rejected

The organiser may partially refund entry fees, if a competitor cannot take part in the event due to a duly proved case of force majeure. The deduction will be:

- 50% of the entry fee for the requests received until 20 days before the administrative checks.
- 100% of the entry fee for the requests received less than 19 days before the administrative checks.

3.7 ADMISSION OF DRIVERS

The Organizing Committee reserves its right to reject a competitor's entry without explaining their decision.

In order to register at any event of the Bajas World Cup, any driver of any nationality being over 18 years old, must hold a FIM competitor license for FIM Cross-Country Rallies World Championship or Bajas World Cup, valid for the year of the event (art.70.2.1 of the FIM Sporting Code and art. 09.1 FIM Medical Code), released by his NMF, and a driving license corresponding to his vehicle's capacity.

A competitor registering at the HunGarian Baja, does it with full awareness of the risks included in this event. The rider releases in advance to the Organizer, his NMF and FIM by any penal or civil responsibility in case of damages or injuries occurred along his participation at HunGarian Baja.

4. INSURANCE

4.1 TRAFFIC INSURANCE:

Third party risk insurance (Traffic insurance) is compulsory for all crews taking part in the rally. All competitors must have a traffic insurance policy and present it at the administration checking. This insurance is valid both on road sections and special stages.

4.2 INSURANCE COVER:

Name of the insurance company:

SRC SPECIAL RISK CONSORTIUM GMBH, Kuniberts kloster 7-9, D 50668 KÖLN.

The limit of the responsibility is 3.000.000 Eur.

In case of an accident leading to insurance event, the competitor or his representative must make a written statement to the Clerk of the Course, the Competitors Relations Officer, or directly to the Organizer, within 24

hours. This statement must mention the accident circumstances, the names and addresses of the casualties, as well as contact details of the witnesses.

Loss or injury that may be suffered by the drivers themselves or participating vehicles is EXCLUDED. Irrespective of this Third Parties insurance, entrants and drivers are free to take out the policies they deem fit on their own account and at their own discretion. Service vehicles, including those displaying the plates supplied by the Organization, shall under no circumstances be deemed participating vehicles. They are therefore not covered by the Organization's insurance policy and responsibility for them lies solely with their owners. In case of accident, competitors and drivers exempt the event organizers from any liability and waive any right to bring claims against them.

The insurance cover will come into effect from the administrative checking and scrutineering for the Event and end upon the expiry of one of the following time limits, whichever is the later:

- time limit for protests or appeals or the end of any hearing by the Stewards;
- end of the administrative checking and post-event scrutineering;
- end of the prize-giving

5. ADVERTISING / IDENTIFICATION

5.1 COMPETITORS ARE ALLOWED TO AFFIX ANY KIND OF ADVERTISING ON THEIR VEHICLES, IF:

- a) They are authorised by FIM regulations and by the laws of the Country
- b) They are not against public decorum.
- c) They do not prevent the use of the reserved spaces to the number holder plates and to compulsory advertising of the Organization.

5.2 RESERVED SPACES FOR ORGANIZER ADVERTISING:

The logos will be published in Bulletin

- 1 - Three race number panels with compulsory advertising 20 x 20 cm on each side and on the front of the vehicle
- 2 - One rally plate placed vertically at the front of the vehicle
- 3 - One race number panel with compulsory advertising 30 x 30 cm to the back of the Riders jacket
- 4 - Advertising sticker (30x30 cm-can be cut to so that it can be easily affixed)

Compulsory or optional advertising absent or incorrect affixing will entail a penalty of 50% of the entry fees. In case of repeated offence, it will go up to exclusion.

6. TYRES

Tyres normally available from commercial or retail sources are authorised. Riders will be free to choose tread pattern and compound.

Both tyres, front and rear, must have an "E" mark and/or DOT (American Department of Transportation) approval and the DOT number must be molded on the tyre wall.

7. FUEL

According to Art. 82.9 of FIM Baja World Cup Regulations

On SS2A, SS2B and SS3A, SS3B will be a Neutralization Zone for all Competitors and a separate Remote Refuelling Zone (RRZ) for Motor, Quad, SBS vehicles only.

8. ADMINISTRATIVE CHECK

Before Administrative Check, each vehicle must **Register** at Suzuki Mészáros, Grábler Tó str.10, where the Checklist and Service Plates will be provided.

8.1 LOCATION: Thury Castle, Hunyadi Mátyás Tér 1., 8100 Várpalota

GPS COORDINATE: N 47° 5'7"E 17°58'10"

8.2 TIMES/ SCHEDULE:

Friday 05. August 2022. 07:00-12:30

The scheduled times for the Administrative and Technical Check for each competitor will be published on the official website www.hungarianbaja.com and communicated to all crews by email on 29.07.2022.

A time control before the Administrative Checks (C1) will be set up, according to the individualized timetable, as well as after the Administrative Checks.

Any delay to the C1 control will be penalized as follows:

- From 1 to 15 minutes: 150€ fine
- From 16 to 30 minutes: 250€ fine
- From 31 to 60 minutes: 500€ fine
- More than 60 minutes: 500€ fine and report to the Stewards.

8.3 DOCUMENTS TO BE PRESENTED:

To minimize the time required for administrative check, please make a photo or scan copies of the documents required, and send them to the following email address: julianna@hungarianbaja.com.

Make sure to bring and present the original of the documents as well:

- Competitor's licence
- Driving licence
- Vehicle's registration document
- Vehicle's compulsory insurance policy
- Autorization (if needed)

9. TECHNICAL SCRUTINEERING

9.1 LOCATION: Suzuki Mészáros, Grábler Tó str. 10, 8100 Várpalota, GPS: N47°11'58, E18°19'13

9.2 TIME/SCHEDULE: Friday 05. August 2022 07:30-12:30

The scheduled times for Administrative and Technical Check will be published on the official website www.hungarianbaja.com, and communicated to all crews by email, on 29.07.2022.

There will be a time control before the Scrutineering (C3). The competitors should check-in to this time control according the individual schedule.

Any delay to the C3 control will be penalized as follows:

- From 1 to 15 minutes: 150€ fine
- From 16 to 30 minutes: 250€ fine
- From 31 to 60 minutes: 500€ fine
- More than 60 minutes: 500€ fine and report to the Stewards.

9.3 REQUIREMENTS AT TECHNICAL SCRUTINEERING:

- Vehicles must presented with all start numbers, rally plates, and advertisements afixed properly on the designated place.
- Tracking equipment and inter-vehicle signalling system installed and operable even when the ignition removed, it is compulsory to provide 12V
- Scrutineering Sheet- filled up
- Competitor's helmet

9.4 INSTALLATION OF THE SAFETY TRACKING SYSTEM AND NAVIGATION SYSTEM

9.4.1 TRACKING AND NAVIGATION SYSTEM (NAV-GPS)

All vehicles must only be fitted with the Safety Tracking System(s) provided by the Organiser. The instruction for the use of the Tracking System is in the Appendix 5 of these Supplementary Regulations. Delivery and installation of the equipment will be carried out before the administrative checks. Every competitor must return the equipment at the end of the competition, or, if a crew retires- to the STELLA Crew.

9.4.2 CONNECTION OF THE SYSTEMS

It is the competitor's responsibility to ensure that the Safety Tracking System(s) and the NAV-GPS always remain permanently connected and switched on with the antenna connected throughout the duration of the competition.

9.5 PARC FERMÉ

Following the technical scrutineering, each vehicle must be set in Parc Fermé up to 15:00.

Location: Szabadság Tér, 8100 Várpalota

10. QUALIFYING STAGE (QS)

Qualifying Stage will be held on 05th August 2022 16:45.

This stage must be performed for each competitor. Any delay in reporting to the start of the Stage will be penalized at the rate of one minute per minute's delay. Vehicles arriving more than 30 minutes late will not be allowed to start. For the QS, times will be taken in hours, minutes, and seconds.

In case of dead heat, priority will be given to the crew who achieved the time first. It shall count for the classification of the event. Any road or other time penalties incurred will be taken into account for the general classification of that leg and applied the same day but will not affect the starting order of the following selective section except for such penalties involving jump starts, shortcuts, or other matters which materially affect the competitor's performance on the QS itself. Start order of the Leg1 Section2 is the QS overall order, Bikes and Quads are together.

11. START OF THE EVENT

11.1 PUBLICATION OF START LISTS: According to Programme.

11.2 BRIEFING:

LOCATION: Thury Castle, Hunyadi Mátyás Tér 1., 8100 Várpalota

TIME: Friday 05.08.2022 at 15:45

Briefing is compulsory for each competitor, who must confirm his presence by signature.

11.3 ROAD BOOK PROVIDING: at the BRIEFING.

12. RUNNING OF THE EVENT

12.1 PARC FERMÉ BEFORE THE OFFICIAL START

In Start Parc Fermé, crews should be ready 15 minutes before the individual ideal starting time.

12.2 TIME CARD PROVIDING/EXCHANGES

Time cards will be issued before the Start of each Leg, which must be submitted to the marshalls at the Finish of each Leg.

Time card exchanging: at regrouping.

12.3 STARTING PROCEDURE FOR THE SPECIAL STAGE will be as follows:

The start of the selective section is happening based on an electric clock and lamp, connected to a false start alert system. A digit display will show continuously the time progressing.

The Marshalls will call out loud the 30, 15, 10 seconds then point towards the start equipment. Beginning from the 55 seconds, red lights will be flashed per every second, then at 00 seconds the red lights will go off and below, the green lights will go up. This will be the time to start.

In case the equipment goes wrong, the marshalls will change to manual starting procedure.

12.4 After Leg 1, and for the following legs, the start will be given following the order of the Selective Section Classification of the previous leg and every 1 minutes.

In case of 2 or more successive selective sections, the starting order of the next day's leg will be drawn up by cumulating the times of these selective sections. In case of an ex aequo, priority will be given to the crew who achieved the fastest time in the 1st selective section.

Any vehicle reporting late for the start of a Leg shall be penalised at a rate of one minute for every minute of lateness. If lateness exceed 1 hour the start will be refused (Ref. Art. 82.15.1), or receive a Fixed Penalty where appropriate.

Publication of START LIST:

Digital Notice Board: [Sportity](https://www.sportity.com), www.chronomoto.hu, www.hungarianbaja.com

12.5 CLOSED CONTROL

Control post must be ready to function 1 hour before the target time for the passage of the first crew. Unless the clerk of the course decides otherwise, they will cease to operate 1 hour after the target time for the last crew, plus the maximum time allowed for the last competitor.

Any crew with a delay higher than 30 minutes at any time control, will have the start refused for the following section, but will not be eliminated from the event.

Penalty to be imposed will be:

30 minutes for the delay in this control, adding the penalty for not taking the Start in the following SS, and adding the maximum time authorized for the selective section not completed.

Example:

Sector

Maximum time allowed: 01h 00'

Case 1 – Competitor n°1	Start	C.H.1	12h 00 '	
	Arrival	C.H.2	13h 00 '	penalty = 0'
Case 2 – Competitor n°1	Start	C.H.1	12h 00 '	
	Arrival	C.H.2	13h 30 '	penalty = 30'
Case 3 – Competitor n°1	Start	C.H.1	12h 00 '	
	Arrival	C.H.2	13h 31 '	penalty = 30' + penalty for not taking Start in following S.S. + maximum time allowed for following S.S.
Case 4 - Competitor n°1	Start	C.H.1	12h 00 '	
	NO ARRIVAL TO	C.H.2'		penalty = 30' + penalty for not taking Start in following S.S. + maximum time allowed for following S.S.

12.6. EARLY CHECK-IN AT END OF LEG

At TC1E, TC3C, TC5C, Parc Ferme IN at the end of a Leg.

12.7. It is strictly forbidden to enter or leave a control area from any direction other than specified by the Road-Book, or to re-enter a control area once checking in has taken place at this control.

12.8. LENGHT OF SELECTIVE SECTIONS

Leg 1:	283,39	km
Leg 2:	132,52	km

Overall SS distance and total distance of the itinerary

Number of Legs	2	
Number of Sections	5	
Number of Selective Sections	5	
Total distance of the itinerary	565,54	km
Overall length of Selective Sections	415,91	km

12.9. RECONNAISSANCE

Reconnaissance of the route (exception QS by walk or nonmotorized bicycle) is totally forbidden. Possession of route notes or other informations different from those given by the Organization is forbidden. Penalty decision at Jury's discretion.

The only official route is that set out in the Road-Book.

To help competitors, the Organizer will indicate intersections and features of the route by means of arrows and tapes. The Road-Book shall be the only official document to be followed.

13. FIXED PENALTY

TIME CONTROLS – MAXIMUM TIME ALLOWED – PENALTIES

A maximum lateness of 30 minutes for every Road section and a total lateness of 30 minutes in road sections of a Leg is authorised. This lateness will be penalised at a rate of 1 minute per minute or fraction of minute according the Art. 38.8 of General Prescriptions 2022.

For each Selective Section a maximum time authorised for the respective Sections will be the following:

	FRIDAY	SATURDAY		SUNDAY	
TIMES ON SELECTIVE SECTIONS	SSS 7,69 HH:MM	SS2 140,23 HH:MM	SS3 140,23 HH:MM	SS4 66,79 HH:MM	SS5 66,79 HH:MM
Maximum time	00:30'	03:40'	03:40'	02:00'	02:00'
Finish in the Maximum time	Time taken	Time taken		Time taken	
Don't finish in the Maximum Time and having take the Start	00:30'	05:00'	05:00'	03:00'	03:00'
Not Starting	01:00'*	08:00'***	08:00'***	05:00'	05:00'

* Subject to approval by the Stewards and force majeure.

** You must have taken start at that Leg.

Maximum time allowed may be modified by the Stewards upon the proposal of the clerk of the Course in case of non - predictable circumstances (climate, modifications in section distance, etc..)

This penalty is only applicable to crews, who:

- Complete at least 50% of the number of the selective sections of the race.
- Have started on every Leg.

If any of the above requirements are not met, the competitor is excluded from the event.

* OTHER PENALTIES	H:M:S
For each CP passage missing, * if the crew have take the start	1:00:00
For each CP stamp missing, * if the crew have take the start	0:30:00

* These penalties shall be added to the time of the corresponding SS to obtain the total time elapsed.

14. SERVICE PARK

14.1 LOCATION:

GÁL GYULA SPORS HALL parking lot (with shower and toilet facility in the Sports Hall)

8100. Várpalota, Fehérvári str. 9.

Servicing a competing vehicle will be permitted only at service areas specified by the Organization. Repairs that may be carried out by a team using on-board equipment or equipment carried by another participant in the race are authorized along the whole route. Any other external servicing outside the authorized areas is forbidden and shall be penalized by EXCLUSION at the Jury's discretion.

14.2 ACCESS TIMES FOR SERVICE VEHICLES

According to Programme.

14.3 OPERATION OF THE SERVICE AREAS

Entry will be permitted only to Service Vehicles showing the Service Plates. Accompanying team cars can enter only by purchasing a 100€ sticker at the Administrative Checks. Tampering with or falsification of the Service Plates will lead to disqualification of the team to which these service vehicles belong.

The Service Plates will be placed in a visible area of the front windscreen of the vehicle. Each crew will receive one Service Plate free.

The maximum speed allowed in the service parks is 30 km/h

Using a min 2x1m protector groundsheet under the racing vehicles is mandatory. 1pc at least 4kg validated manual fire extinguisher is mandatory. Each service team has to ensure that after carrying out their activities on

the site, they do not leave any pollutants. They will be checked by the scrutineers, and not complying will entail a 50.000HUF fine.

Washing and Refuelling is strongly prohibited in the total area of the Service Park!!!

The Organizer calls the attention of the participants, that the Service Park is not guarded at night time!

14.4 REFUELLING

Refuelling is permitted only in commercial fuel stations using fuel on sale to the public. Only the crew may carry out this procedure.

On SS2A, SS2B and SS3A, SS3B will be a Neutralization Zone for all Competitors and a separate Remote Refuelling Zone (RRZ) for Motor, Quad, SBS vehicles only.

The Refuelling station authorised will be indicated in the Road Book with "FUEL STATION".

15. FINAL CHECKS / PROTEST / APPEALS

15.1. FINAL CHECKS

Time and location: see Programme

Any teams required to undergo final checks must immediately follow the instruction of the marshals in charge, even if this prevents them from proceeding to one or more time controls (TC).

15.2. PROTEST

Any complaint shall be presented according to requirements of the Disciplinary and Arbitration Code. They must be submitted by writing to the Clerk of the Course, within the required dates, by the concerned competitors and not by third parties.

Protest deposit: 660€

16. RESULTS

The Provisional overall classification will be published:

Digital Notice Board: Soportity, www.chronomoto.hu, www.hungarianbaja.com

17. PRIZES

17.1 PRIZE GIVING CEREMONY

LOCATION: Várpalota Főtér, Szabadság Tér

TIME: Sunday 07. August 2022 16:00

17.2 PRIZES:

FIM CATEGORY (1 / 2 / 3) - 1st to 3rd CUPS

FIM CLASSES (1 / 2 / 3) - 1st to 3rd CUPS

The organizer can foresee other prizes too.

Prize giving for the National Open Event will be held according to the MAMS regulations of this series.

The prizes will only be given to these Categories, Groups and Classes, if there is a minimum of 5 participants at the start, otherwise only the first given prizes.

At the entire route of the event, the national traffic rules must be respected.

FIM approval:

MAMS Nr:

EMN Nr:

IMN Nr: 814/05

APPENDIX 1. – COMPETITOR RELATIONS OFFICERS

Names and photographs of the Competitors Relation officer(s) and their schedules



(ENG + HUN)
Mrs. Marianna MAGYAR KELEMENÉ
+36 70 944 5148



(ENG + HUN)
Mr. István MÁTRAI
+36 20 417 6249

Estimated working plan:

Thursday 04. August	Admin check Scrutineering	08:00-19:00 10:00-21:00
Friday 05. August	Parc ferme Briefing / Start TC / Start Ceremony	12:00-15:00 16:00-22:00
Saturday 06. August	Parc ferme Service area Parc ferme Service area Parc ferme	08:00-10:00 11:00-13:00 13:00-14:00 14:00-16:00 17:00-19:00
Sunday 07. August	Parc ferme Service area PF/Parc ferme / Finish Ceremony	08:00-10:00 10:00-11:00 12:00-18:00

APPENDIX 2. – TIMETABLE



HUNGARIAN BAJA

MOTO

Leg 1								2022.08.05. FRIDAY / PÉNTEK	
Sunrise		5:29		20:17		Sunset			
IE/TC	Location	SS Maximum Time	SS Km	Liasion Km	Total Km	Target Time	1st vehicle Due		
TC0	VÁRPALOTA Parc Ferme OUT						16:45		
TC1	Várpalota			3,33	3,33	0:10	16:55		
DSS 1	SSS1 START					0:05	17:00		
ASS 1	SSS1 FINISH	0:30	7,31		10,64	(0:05)	(17:05)		
	Várpalota					(Expected time of arrival)			
RZ 1	Refueling, Petrol Station, 14km.								
TC1A	Service IN			3,95	14,59	0:25	17:30		
SERVICE A									
TC1B	Service OUT			0,83	15,42	1:05	18:35		
TC1C	Regrouping IN			0,51	15,93	0:05	18:40		
REGROUPING									
TC1D	Regrouping OUT / Podium Start Ceremony						20:00		
TC1E	Parc Ferme IN / Early Check-IN is Authorised			0,15	16,08	0:30	20:30		
Day Total			7,31	8,77	16,08				
			45,46%	54,54%	100%				

Section 1



HUNGARIAN BAJA

MOTO

Leg 1								2022.08.06. SATURDAY / SZOMBAT	
Sunrise		5:30		20:15		Sunset			
IE/TC	Location	SS Maximum Time	SS Km	Liasion Km	Total Km	Target Time	1st vehicle Due		
TC1F	Parc Fermé OUT						8:00		
TC2	Várpalota			2,63	2,63	0:10	8:10		
DSS 2A	START					0:05	8:15		
ASS 2A	FINISH	2:00	81,96		84,59	(0:55)	(9:10)		
	Gyulaifirátót						(Expected time of arrival)		
Neutralization zone / FIM & MAMS REFUELING ALLOWED									
	Gyulaifirátót			1,52	86,11	0:15	9:25		
DSS 2B	START						9:25		
ASS 2B	FINISH	1:40	56,08		142,19	(0:40)	(10:05)		
	Újmajor						(Expected time of arrival)		
RZ 2	Refueling, Petrol Station, 14km.								
TC2A	Service IN			33,01	175,20	0:50	10:55		
SERVICE / SZERVIZ B									
TC2B	Service OUT			0,83	176,03	0:40	11:35		
TC2C	Regrouping IN			0,51	176,54	0:05	11:40		
REGROUPING									
TC2D	Regruping OUT						12:15		
TC3	Várpalota			2,63	179,17	0:10	12:25		
DSS 3A	START					0:05	12:30		
ASS 3A	FINISH	2:00	81,96		261,13	(0:55)	(13:25)		
	Gyulaifirátót						(Expected time of arrival)		
Neutralization zone / FIM & MAMS REFUELING ALLOWED									
	Gyulaifirátót			1,52	262,65	0:15	13:40		
DSS 3B	START						13:40		
ASS 3B	FINISH	1:40	56,08		318,73	(0:40)	(14:20)		
	Újmajor						(Expected time of arrival)		
RZ 3	Refueling, Petrol Station, 14km.								
TC3A	Service IN			33,01	351,74	0:50	15:10		
SERVICE / SZERVIZ C									
TC3B	Service OUT			0,83	352,57	1:20	16:30		
TC3C	Parc Ferme IN / Early Check-IN is Authorised			0,51	353,08	0:05	16:35		
Day Total			276,08	77,00	353,08				
			78,19%	21,81%	100%				

Section 2

Section 3



HUNGARIAN BAJA

MOTO

Leg 2		2022.08.07. SUNDAY / VASÁRNAP						
Sunrise 5:31							20:14	Sunset
IE/TC	Location	SS Maximum Time	SS Km	Liasion Km	Total Km	Target Time	1st vehicle Due	
TC3D	Parc Fermé OUT						8:00	
TC4	Gyulafrátót			27,49	27,49	0:40	8:40	
DSS 4	START					0:05	8:45	
ASS 4	FINISH	1:40	66,26		93,75	(0:45)	(9:30)	
	Várpalota					<i>(Expected time of arrival)</i>		
RZ 4	Refueling, Petrol Station, 14km,							
TC4A	Service IN			3,95	97,70	0:25	9:55	
SERVICE / SZERVIZ D								
TC4B	Service OUT			0,83	98,53	0:40	10:35	
TC4C	Regrouping IN			0,51	99,04	0:05	10:40	
REGROUPING								
TC4D	Regruping OUT						11:15	
TC5	Gyulafrátót			27,49	126,53	0:40	11:55	
DSS 5	START					0:05	12:00	
ASS 5	FINISH	1:40	66,26		192,79	(0:45)	(12:45)	
	Várpalota					<i>(Expected time of arrival)</i>		
TC5C	Parc Ferme IN / Early Check-IN is Authorised			3,62	196,41	0:10	12:55	
Prize Giving and Podium Ceremony							16:00	
Day Total			132,52	63,89	196,41			
			67,47%	32,53%	100%			
			SS km	Liasion km	Total km			
Rally Total			415,91	149,66	565,57			
			73,54%	26,46%	100%			



MAIN SCREEN

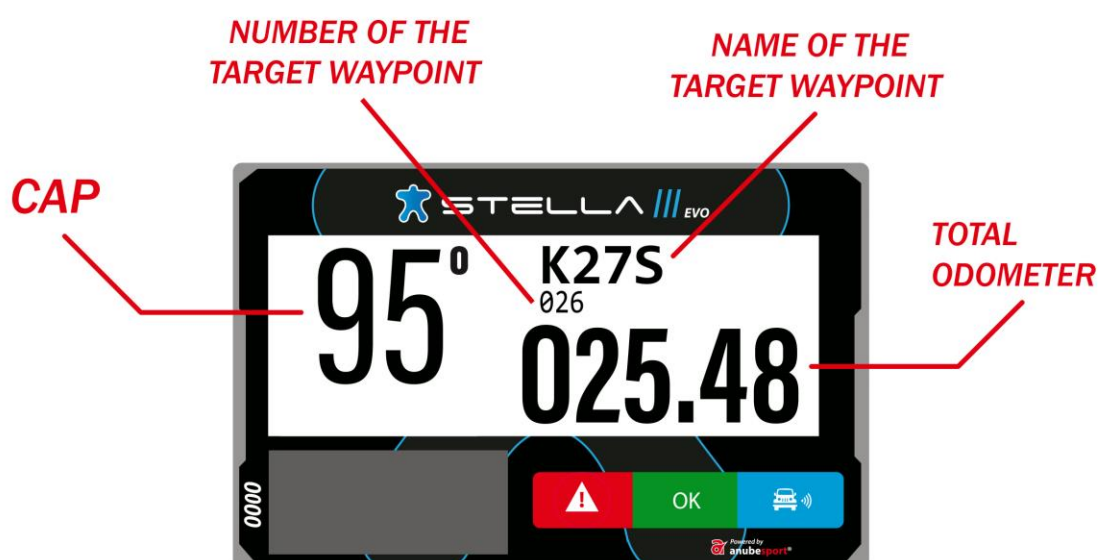

WAYPOINT PROXIMITY



SPEED ZONE

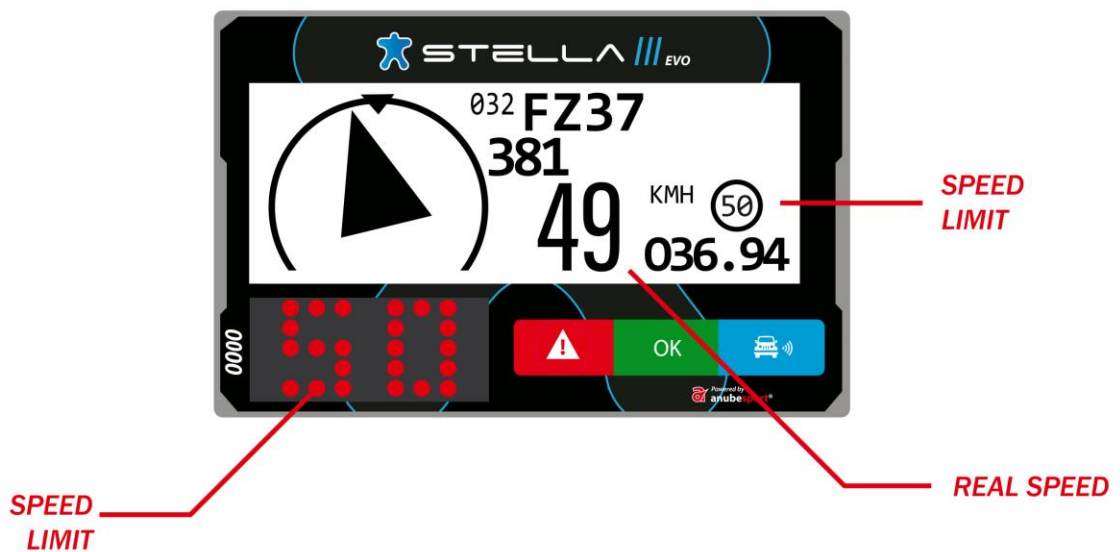

REQUEST MEDICAL ATTENTION IMMEDIATELY

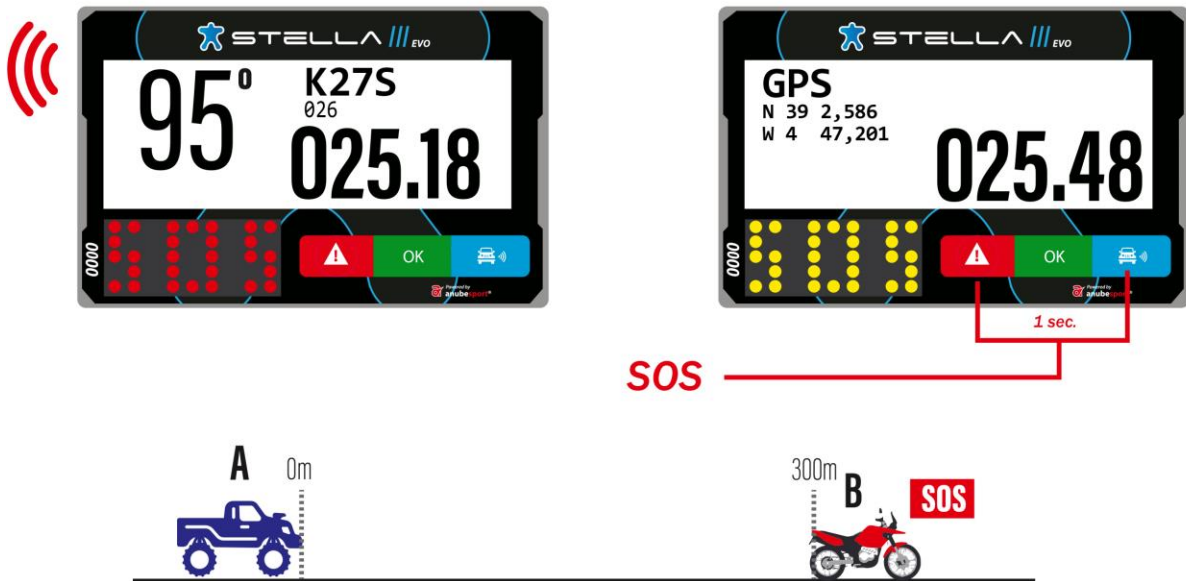

CAUTION VEHICLE STATIONARY

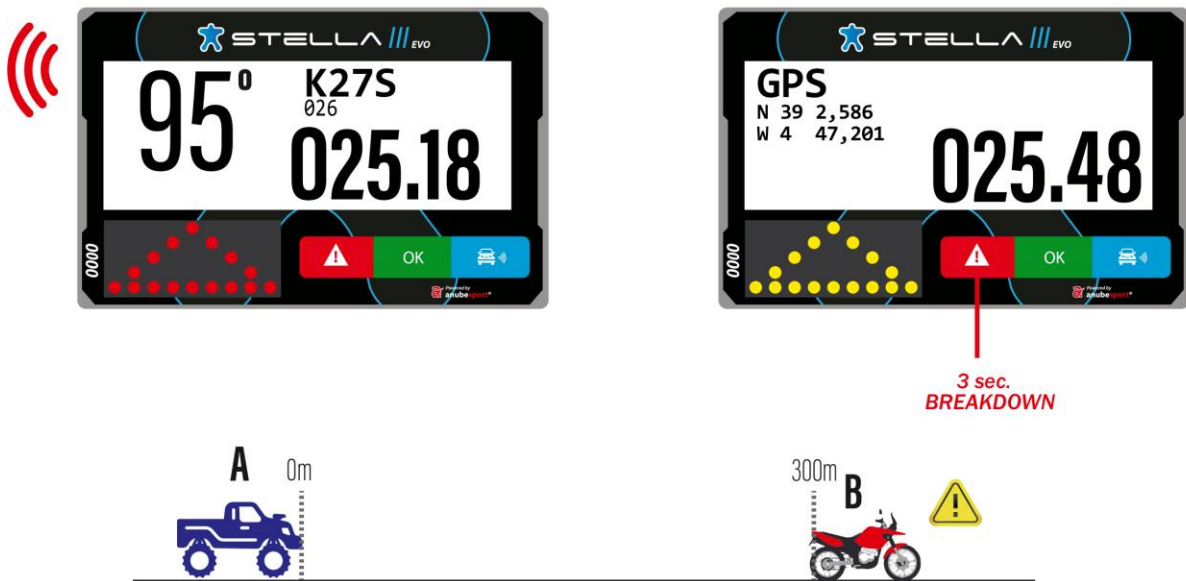

DANGER 3 !!!



Notification 300m before an area marked in the roadbook as "Danger 3"

OVERTAKING / BLUE FLAG



OVERTAKING / BLUE FLAG



STEADY



FLASHING



OVERTAKING / BLUE FLAG



FREE TO OVERTAKE



STEADY

PRESS THE BLUE BUTTON TO CONFIRM

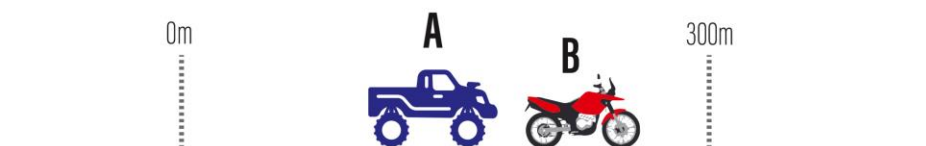

SPEED LIMIT

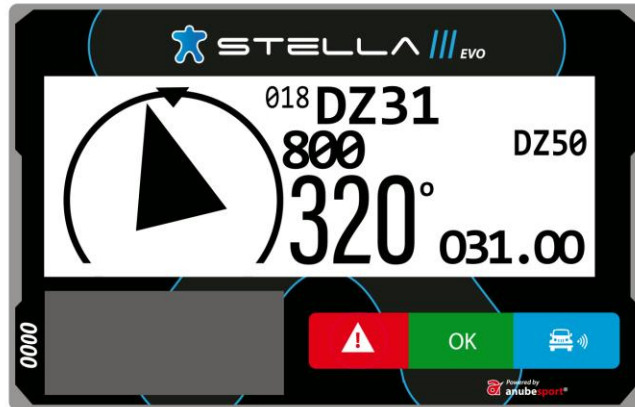

SPEED LIMIT

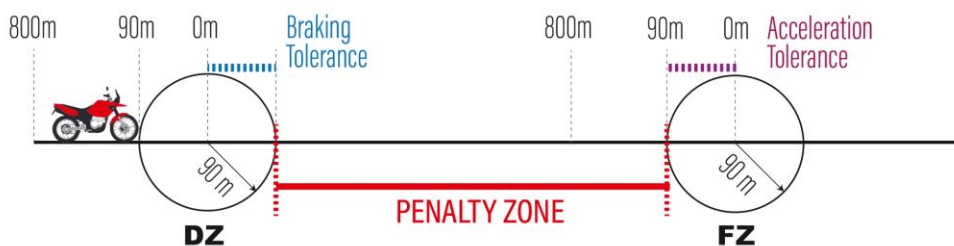
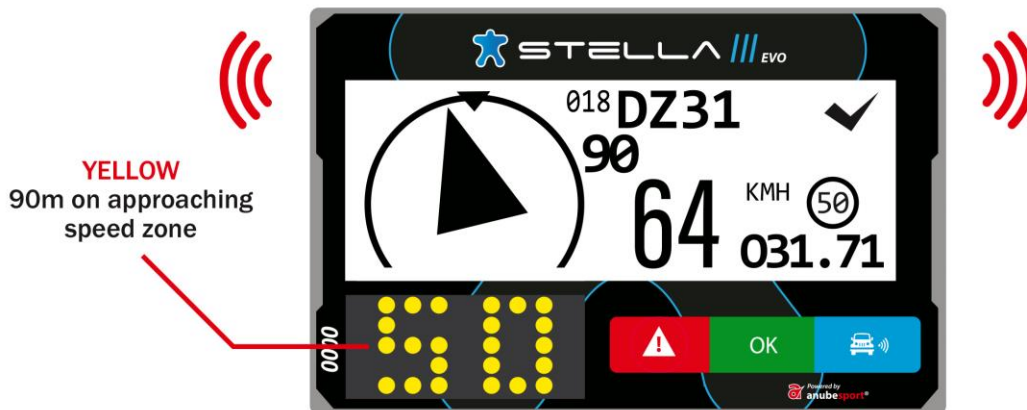

SPEED LIMIT

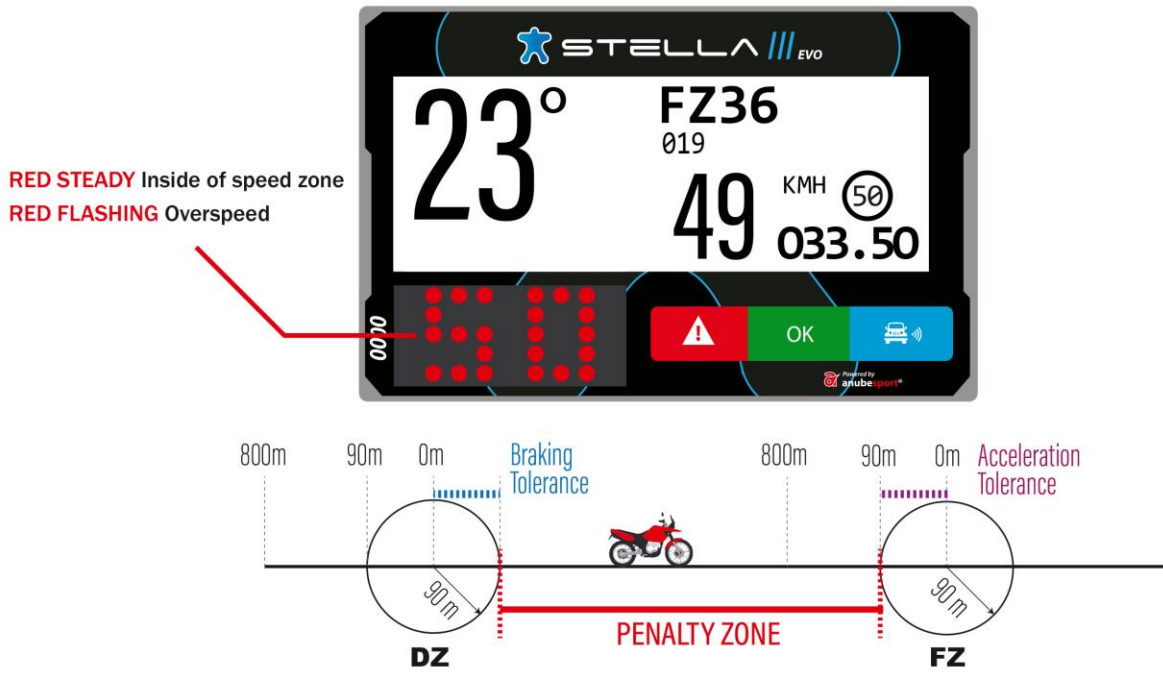

SPEED LIMIT

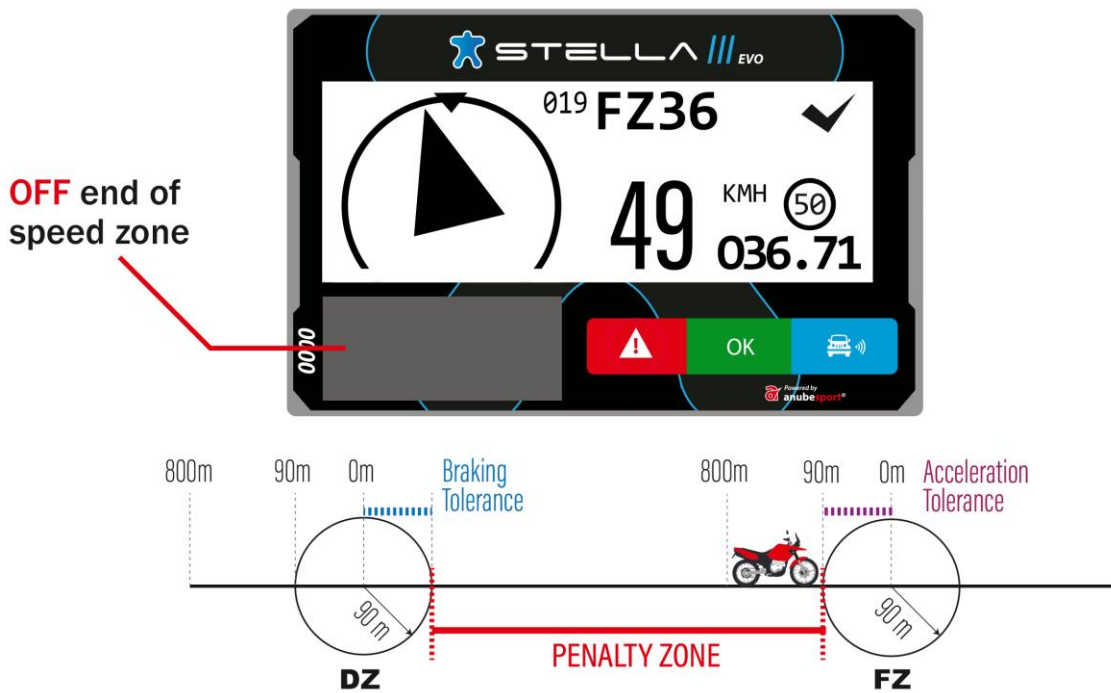

NEUTRALIZATION ZONE

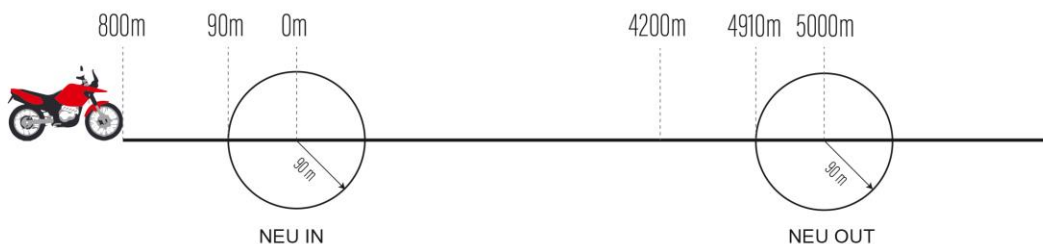

NEUTRALIZATION ZONE

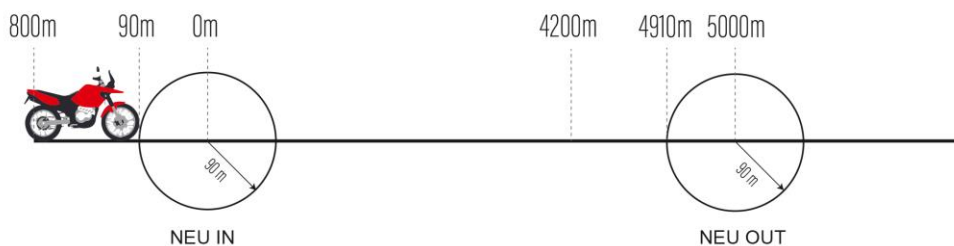
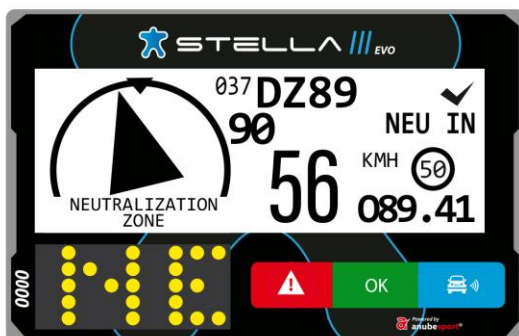

NEUTRALIZATION ZONE

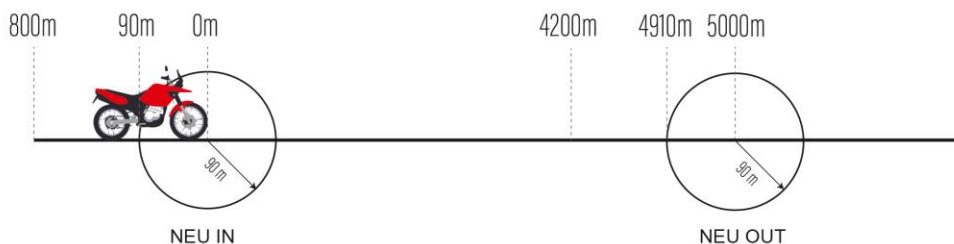

NEUTRALIZATION ZONE

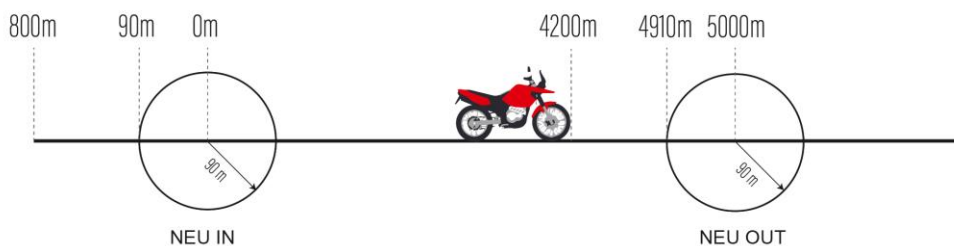
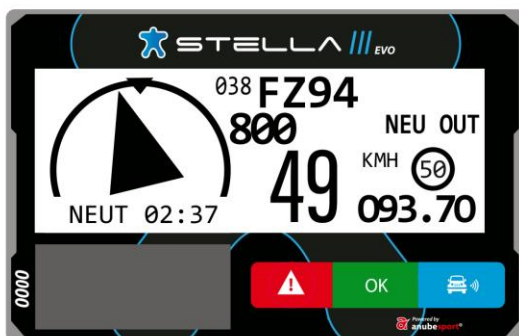

NEUTRALIZATION ZONE

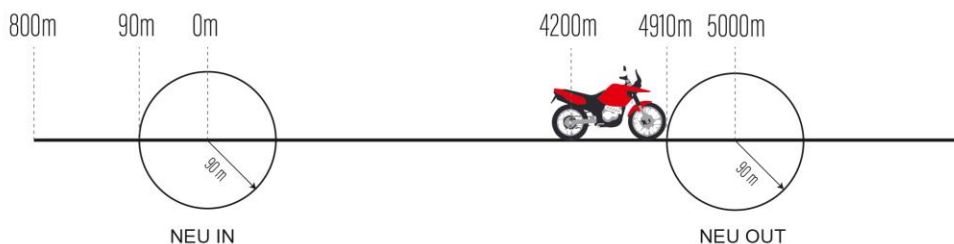

NEUTRALIZATION ZONE

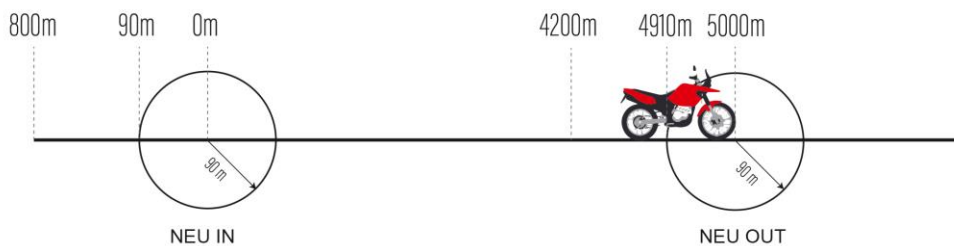

MESSAGES



WAYPOINTS LIST



TOTAL ODOMETER RESET TO ZERO



OK

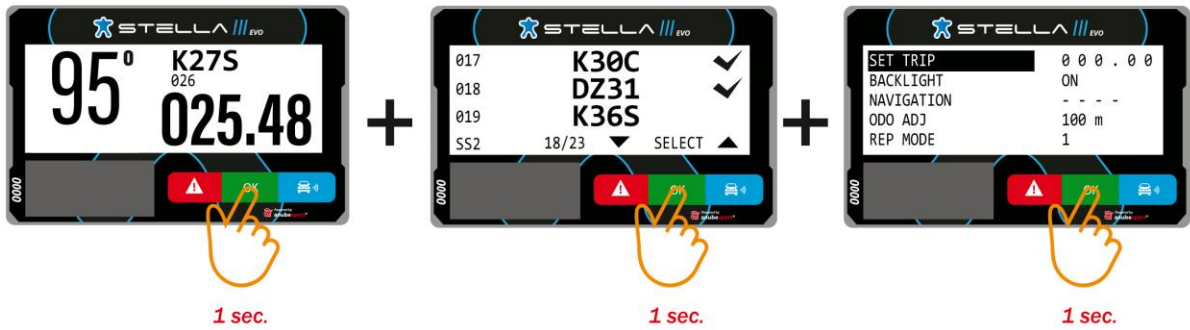

APPENDIX 4. – GPS TRACKING SYSTEM'S INSTALLATION KIT

KIT COMPONENTS

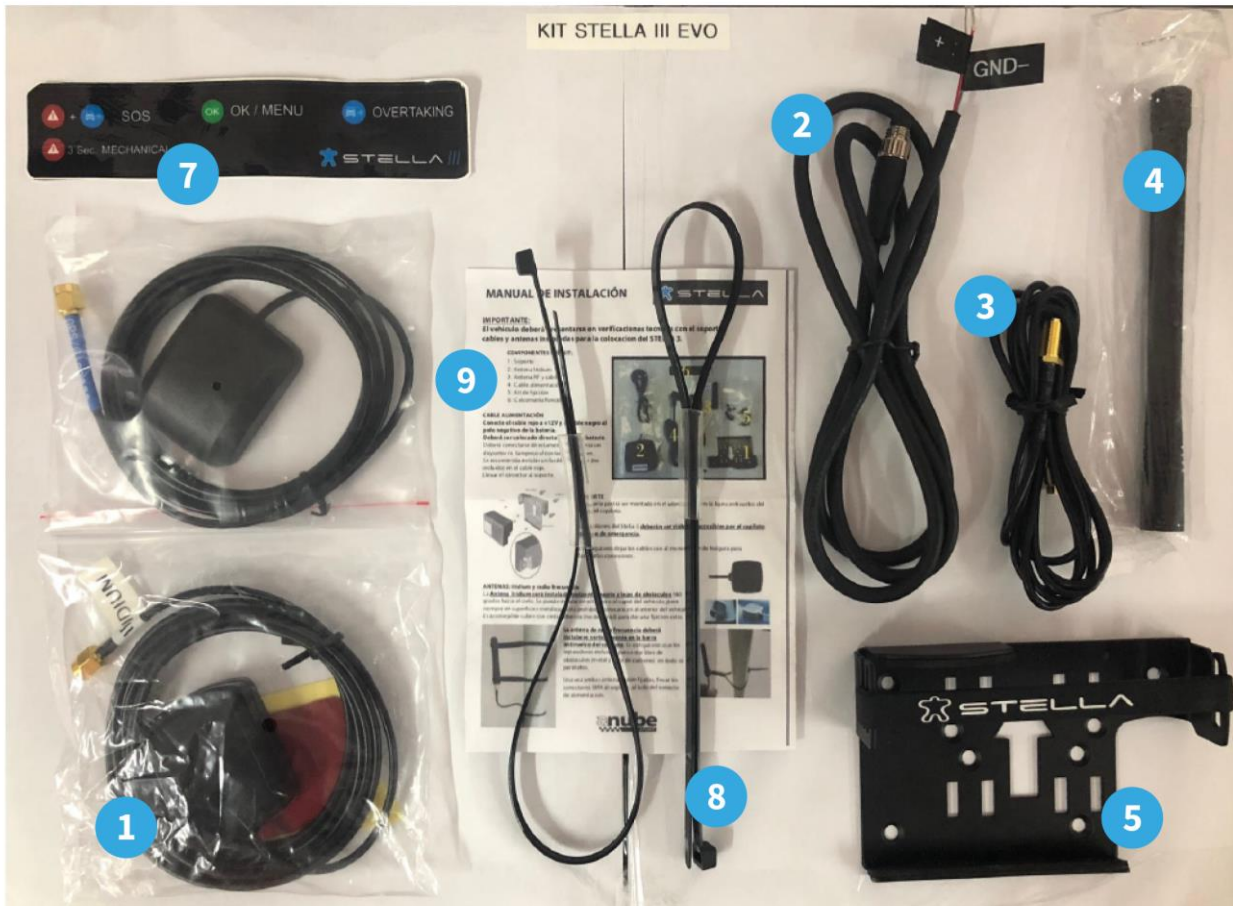

1. Iridium Antenna
2. Power Cord
3. RF Cord
4. RF Antenna
5. Base/Mount
6. GPS Antenna
7. Adhesive
8. Straps
9. User Manual

IMPORTANT

For the functional tests and verification, all vehicles must have gone through the installation of the mount, power cord, and antennas.

1. POWER CORD

- Connect the red wire to the positive end of the battery 12V(+), and the grey wire to the negative end (GRD). The power cord must be connected directly to the battery (without interruptions and without contact in the power supply).
- A 3A fuse (not included) should be connected to the red wire.
- Take the cord to the location in which the STELLA III EVO is to be installed. All other wires must be insulated, they cannot touch.



2. BASE/MOUNT

- Motorcycles and ATV: The mount can be attached to the handle bar or to a metal plaque close to the navigation system.
- Cars and UTV: The mount can be attached to the panel, or to the roll cage bars. STELLA III EVO buttons must be visible and accessible to the participant (pilot/navigator) even when they are sitting and with the seatbelts buckled.

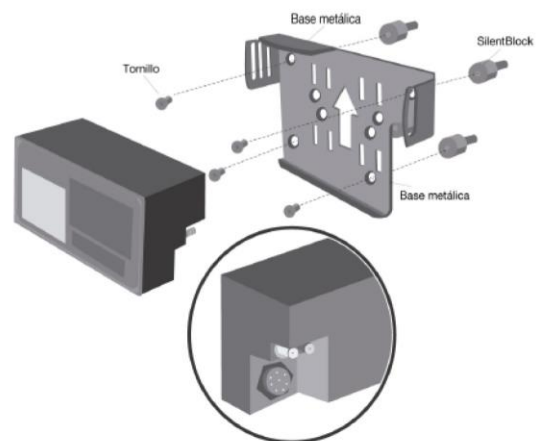

IMPORTANT

Leave the cords (antenna and battery) in place with at least 10 cm to spare for easy handling.

At least 5 cm of space behind the mount (bottom right corner) to allow space for power cord/connections.

3. GPS ANTENNA

The GPS antenna must be installed horizontally and without obstructions toward the sky. In cars and UTV, It can be mounted on the roof, the hood, or the dashboard. In motorcycles and ATV, attach to the mudguard. For additional firmness, it is recommended to cover it with adhesive tape (non metallic when mounting it to a metallic surface) and pull-up (when attached to soft or plastic parts).



4. ANTENNA IRIDIUM

The Iridium antenna must be installed horizontally and without obstructions toward the sky. In cars and UTV, It can be mounted on the roof, the hood, or the dashboard. In motorcycles and ATV, attach to the mudguard. For additional firmness, it is recommended to cover it with adhesive tape (non metallic when mounting it to a metallic surface) and pull-up (when attached to soft or plastic parts).



5. RF ANTENNA

The radio-frequency antenna must be installed vertically to the roll cage bars (cars and UTV) and the forks (motorcycles and ATV). It is mandatory to use separators (included in the kit) to avoid contact with metallic parts and the carbon fibre that surrounds it.

Once the antennas are mounted, take the SMA connection cords to the base/mount where the STELLA III EVO will be installed.

